

SUMP VACUUM CLEANERS FOR OIL AND CHIPS

RAM OIL 500

INDUSTRIAL VACUUM CLEANER FOR LUBRICATING OILS AND SHAVINGS



Watch the video!



POWER
4,3 kW - 5,8 HP



APPLICATION
Oils and lubricants mixed shavings



CAPACITY
500 lt

FEATURES

- Filters and reuses lubricating and cutting oils
- Simultaneous liquid suction and discharge capability
- Simplified liquid collection and swarf management
- Sturdy painted steel construction

HIGHLIGHTS



SUCTION UNIT

The suction unit is a side channel blower with direct coupling between motor and impeller. The turbine is equipped with a safety valve to ensure continuous, maintenance-free work. A metal silencer is included as standard in the turbine to ensure a low noise level.



FILTER UNIT

The collected liquid passes through a liquid filter with an efficiency of 150µ and a grid basket, which trap chips and simplify their disposal. In this way, even the smallest solid particles can be separated, making the filtered liquid suitable for reuse.

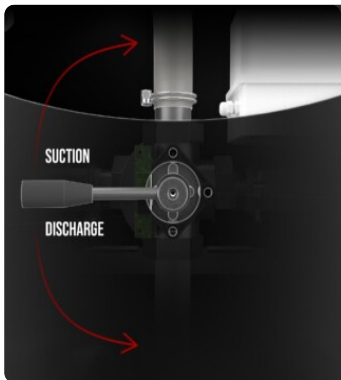

LIQUID DISCHARGE SYSTEM

A convenient lever, located at the rear of the vacuum cleaner, allows rapid switching between suction and container emptying. The reverse flow system uses the exhaust air ensuring the efficiency and speed of the operation.



ACCESSORY KIT INCLUDED

A complete and functional accessory kit is included in the standard equipment of the vacuum cleaner

TECHNICAL DATA

MOTOR

Typologies	Side channel blower
Power	4,3 kW - 5,8 HP
Frequency	50/60 Hz
Voltage	400 V
Vacuum in continuous run	360 mBar
Maximum air flow	320 m3/h
Insulation class	55 F IP
Noise level	72 dB(A)

MACHINE

Suction inlet	50 Ø mm
Collection system	Steel container
Solids capacity	40 lt
Liquids capacity	500 lt
Liquid discharge system	Reverse flow
Dimensions	600 x 1510 mm
Height	1780 mm
Weight	220 Kg
Accessory kit included	P12352
Solid separation	Basket grid
Liquid separation	150µm liquid filter
Safety valve	Pressure relief valve

FILTRATION

Primary filter type	Bag
Media	Polypropylene 150µm

OPTIONS

STRUCTURE AND OPTIONS

60[✓] HZ

60HZ

Available in 60Hz version



BIS

Inspection door for internal maintenance



LIQUID DISCHARGE PUMP

Allows simultaneous suction and discharge of liquid

ACCESSORIES



P12355

OIL & SWARF KIT PRO Ø 50MM

Complete system for collecting oil and metal shavings, with specific accessories for every part of the machine tool. - 3 m of reinforced ...